

Raft Description:

Date October 31, 2002

Raft # 69 145D-69	Type 1 145D T-1	Bld. 750 Name SA69	S3 Ring Name SR??
---------------------------------------	-------------------------------------	-------------------------------------	------------------------------------

Notes:

The above date represents the latest fiducial date of all components listed below.

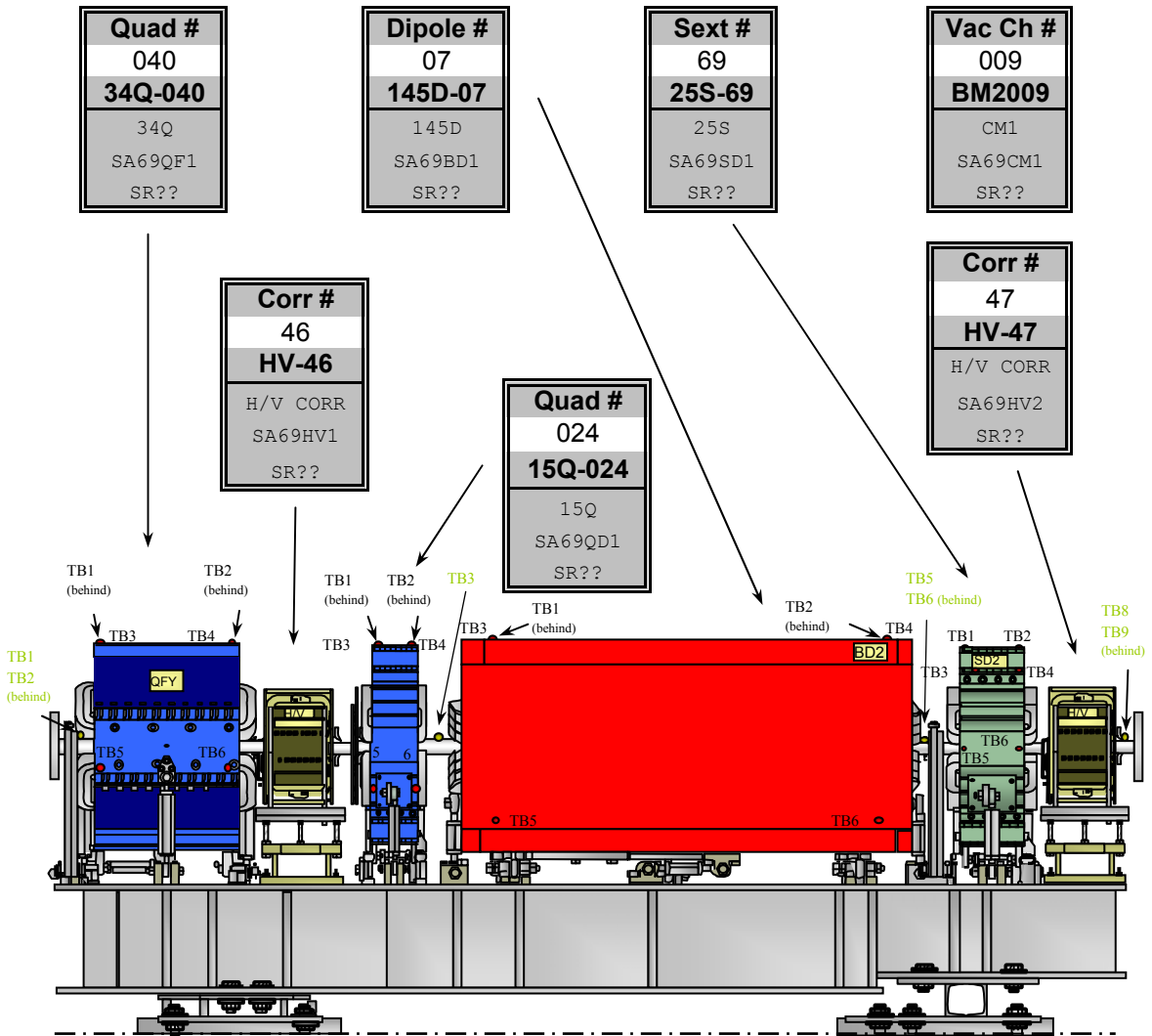

Quadrupole: Fiducial Values for Upstream (34Q) Quadrupole

Fiducial	Z	X	Y
TB1	-6.314	11.221	16.198
TB2	6.298	11.222	16.203
TB3	-6.321	-11.251	16.202
TB4	6.297	-11.236	16.198
TB5	-5.192	-15.200	-4.826
TB6	4.634	-15.199	-4.857

inches inches inches

**QUADRUPOLE
34Q-040**

SA69QF1
SR??

9/5/01

Description:
Fiducials based on values posted on web-page. (Check for updates.)

Vacuum Chamber: Fiducial Values for BM2 Vacuum Chamber

Fiducial	Z	X	Y
TB1	-77.160	-6.218	4.371
TB2	-77.252	7.283	4.382
TB3	-34.863	0.074	4.371
TB4	-0.666	4.029	2.397
TB5	34.499	-4.629	4.388
TB6	35.801	2.552	4.392
TB7	53.850	-4.279	2.419
TB8	58.006	-12.527	2.929
TB9	60.945	3.045	2.955
TB0	N/A	N/A	N/A

inches inches inches

**VACUUM CHAMBER
BM2009**

SA69CM1
SR??

10/31/02

Description:
Fiducials based on values posted on web-page. (Check for updates.)

HV1 Corrector: Fiducial Values for Corrector

Fiducial	Z	X	Y
1	-0.003	-0.323	-10.196
2	-0.002	-10.046	-10.205
A	0.000	-20.003	0.000
B	0.000	-20.003	0.000
C	0.000	-20.003	0.000
D	0.000	-20.003	0.000
E	0.000	0.000	17.935
F	0.000	0.000	17.935
	inches	inches	inches

**HV1 CORRECTOR
HV-46**

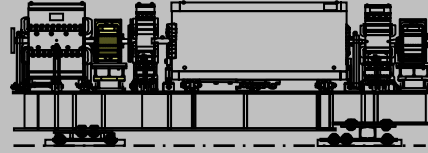

SA69HV1
SR??

No Date

Description:

Fiducials based on known nominal values.

Quadrupole: Fiducial Values for Upstream (15Q) Quadrupole

Fiducial	Z	X	Y
TB1	-2.573	11.233	16.198
TB2	2.565	11.236	16.199
TB3	-2.531	-11.238	16.202
TB4	2.563	-11.225	16.199
TB5	-1.499	-15.201	-4.870
TB6	2.481	-15.202	-4.799
	inches	inches	inches

**QUADRUPOLE
15Q-024**

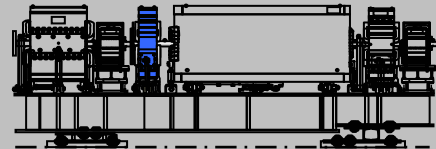

SA69QD1
SR??

9/7/01

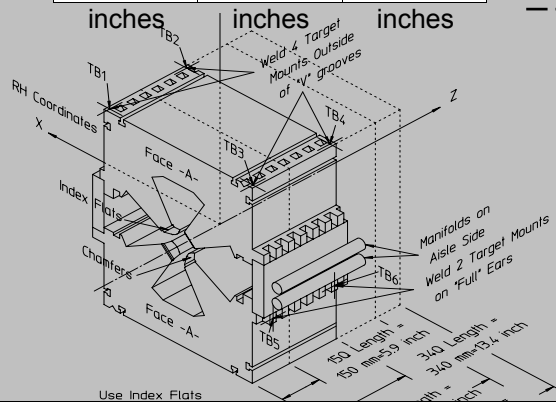

Description:

Fiducials based on values posted on web-page. (Check for updates.)

Gradient Dipole: Fiducial Values for Dipole (145D)

Fiducial	Z	X	Y
TB1	-26.542	3.448	16.997
TB2	26.587	3.448	17.005
TB3	-26.540	-22.414	16.997
TB4	26.590	-22.410	16.999
TB5	-26.497	-24.269	-11.541
TB6	26.423	-24.272	-11.927

inches inches inches

**GRADIENT DIPOLE
145D-07**

SA69BD1
SR??

6/28/01

Description:
Fiducials based on values posted on web-page. (Check for updates.)

Sextupole: Fiducial Values for 25S Sextupole

Fiducial	Z	X	Y
TB1	-4.326	4.215	15.513
TB2	4.338	4.206	15.511
TB3	-4.430	-10.496	12.547
TB4	3.363	-10.584	12.506
TB5	-4.576	-15.062	0.069
TB6	4.546	-15.061	0.034

inches inches inches

**SEXTUPOLE
25S-69**

SA69SD1
SR??

8/13/01

Description:
Fiducials based on values posted on web-page. (Check for updates.)

HV2 Corrector: Fiducial Values for Corrector

Fiducial	Z	X	Y
1	-0.003	-0.323	-10.196
2	-0.002	-10.046	-10.205
A	0.000	-20.003	0.000
B	0.000	-20.003	0.000
C	0.000	-20.003	0.000
D	0.000	-20.003	0.000
E	0.000	0.000	17.935
F	0.000	0.000	17.935

inches inches inches

HV2 CORRECTOR

HV-47

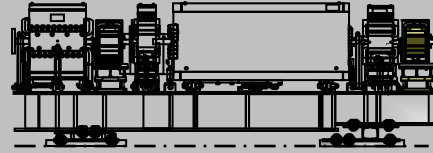

SA69HV2
SR??

No Date

Description:

Fiducials based on known nominal values.

Building 750 Deck: Positions of Component Origins

750 Name	Z	X	Y	Yaw
SA69QF1	-4.114	-0.311	0.000	10.5882
SA69QD1	-3.485	-0.194	0.000	10.5882
SA69CM1	-2.450	0.000	0.000	10.5882
SA69BD1	-2.447	-0.034	0.000	5.2941
SA69SD1	-1.367	0.000	0.000	0.0000

meters meters meters degrees

Date of Deck File: March 10, 2003

145D-69

Location of Raft: EAST

Description:

Deck coordinates representing origin of the specific component's coordinate system.

Building 750 As-Built: (TABLE 1 of 2)

750 Name	delta Z	delta X	delta Y (delta H)
SA69QF1	0.009	0.004	0.002
	0.005	-0.001	0.001
	-0.006	0.007	0.007
	-0.006	0.003	-0.001
	0.012	-0.001	-0.002
	0.009	0.002	-0.001
SA69HV1		0.009	
		-0.005	
		0.007	
		-0.002	
			0.007
			0.003
SA69QD1	0.029	0.002	0.002
	0.025	-0.001	-0.001
	-0.027	0.017	0.007
	-0.024	0.001	-0.001
	N/A	N/A	N/A
	-0.053	-0.003	-0.005
SA69CM1	N/A	N/A	N/A
	N/A	N/A	N/A
	N/A	N/A	N/A
	N/A	N/A	N/A
	N/A	N/A	N/A
	N/A	N/A	N/A
	N/A	N/A	N/A
	N/A	N/A	N/A
	N/A	N/A	N/A
	N/A	N/A	N/A

inches inches inches

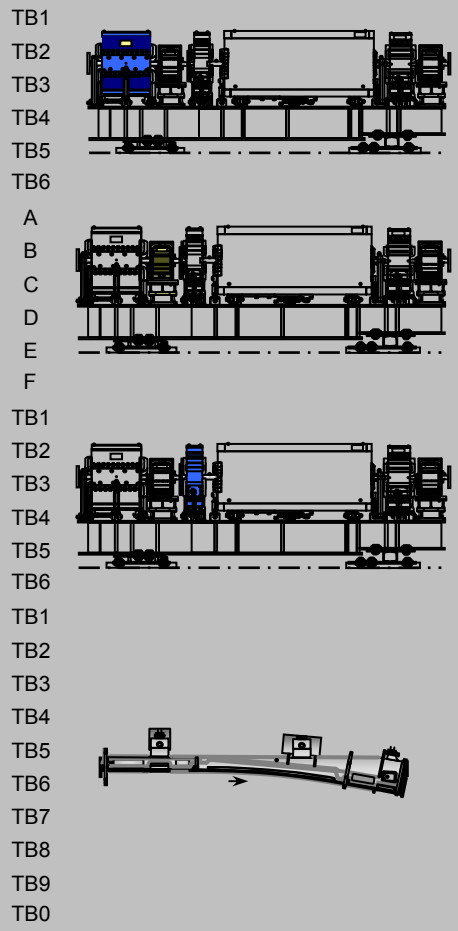

Latest File Date: February 28, 2003

145D-69

Description:

Values representing the difference between the design and actual fiducial measurements.

Building 750 As-Built: (TABLE 2 of 2)

750 Name	delta Z	delta X	delta Y (delta H)
SA69BD1	0.005	0.001	-0.004
	0.004	-0.004	-0.006
	0.010	0.006	0.002
	0.001	-0.005	0.001
	0.009	-0.008	0.004
	0.003	-0.003	0.003
SA69SD1	0.000	0.005	0.004
	-0.001	-0.003	0.006
	-0.013	0.000	0.000
	-0.013	-0.004	0.005
	-0.002	-0.004	-0.003
	-0.008	-0.006	0.002
SA69HV2		0.018	
		0.020	
		0.020	
		0.013	
			-0.001
			0.001
	inches	inches	inches

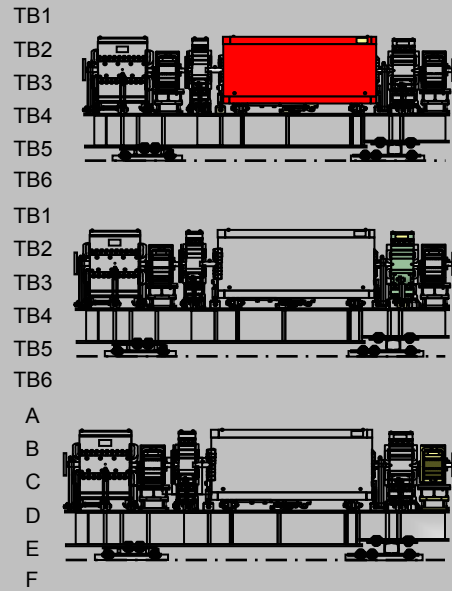

Latest File Date: February 28, 2003

145D-69

Description:

Values representing the difference between the design and actual fiducial measurements.