

SLAC Magnetic Measurement Plan and Traveller for LCLS-II Injector Quadrupole of Type 1.26Q3.5 . Revision 3, dated 23th February 2016

This magnetic measurement plan and traveller is for the style of solid wire quadrupole called 1.26Q3.5 that will be used in the LCLS-II. This particular magnet is the 1st article for a production run of 40 of these quadrupoles and they will be delivered to the Magnetic Measurements Group already fiducialized and without their T1 mount because the MMG will have one T1 mount installed on their measurement table and each quad will be placed on that T1 mount. The beamline number of each quad should already be marked on each quadrupole and the beam direction arrow should be visible. Each quad will have been fiducialized by the CMM in Bld 25 and the fiducialization data will have been transmitted from the group running the CMM to the Alignment Crew who will align the quad on the above-mentioned T1 mount. The overall length of the 1.26Q3.5 quadrupole is about 18cm. It weighs over 60 Kg.

Save this WORD file with a unique name before proceeding further. Each magnet's measurement plan and traveller is in a WORD document and each magnet's WORD file will need to have a unique name to distinguish it from all other magnets' electronic WORD files. It is suggested that the format of the WORD file's name be MstTravName of magnet type_Beamline name of quad, e.g. MstTrav1.26Q3.5_QA01B.docx .

Unique file name of this WORD document:	LCLS-II 4010 1.26Q3.5.docx
---	----------------------------

1. Receiving Information

Received by (MMG initials)	SDA
Date received : (dd-mm-yyyy):	11/18/2016
Look for Magnet Beamline Number and type it here.	
Look for serial number on vendor plate and type it here	011
Magnet Engineer has inspected the magnet assembly traveler and on it you can read that MMG is authorized to do the magnetic measurements in this plan.	
If quad does not have a barcode sticker then ask Magnet Engineer to add one and in any event write the 6 digit barcode number here:	4010

2. Power Supply Required: A bipolar MCOR12 power supply is required, it must work in a smooth bipolar mode from -12 A to +12 A. The beamline PS will be controlled in a "3-Linear trim" mode (will be described below) and so the MMG PS must mimic this way of ramping the current in its PS. There is one set of main coils in this quad style and they are solid wire coils, so there are no LCW connections.

3

3. Magnet Orientation:

A beam direction arrow should be visible on the top or side of the core. The beam direction through this magnet is described thus, look at the magnet so its terminal blocks are on its right hand side, then you are looking downbeam. If there is no arrow, please add a temporary one and inform the Magnet Engineer.

Beam-direction arrow in place (initials):	SDA
---	-----

4. Name and URL of Magnetic Measurements Data Files

All the data files MMG generates should be placed in a subdirectory which has the beamline name of this quadrupole as its identifier. The major directory should include the name LCLS2.

Enter URL of on-line magnetic measurements data (please modify or correct if necessary):

http://www-group.slac.stanford.edu/met/MagMeas/MAGDATA/LCLS-II/quad/4010

5. Magnet Alignment:

This magnet has sockets for 4 tooling balls (TBs), it will come to MMG already fiducialized. Its CMM data will be found in a metrology URL such as the one in the box below.

URL of on-line CMM fiducialization data (please modify or correct if necessary):

http://www-group.slac.stanford.edu/met/MagMeas/MAGDATA/LCLS-II/Quad/Fiducial%20Reports/4010_Fiducial_Report.pdf

Alignment crew should do set up on measurement stand , and use the x,y,z axes of the whole magnet (as defined by TB measurements) such that the roll angle (angle of horizontal axis) is less than 1.0 milliradian for all these injector quadrupoles, except for QS01B and QS02B whose roll angles must be less than 0.2 mr. The pitch and yaw must also be minimized.

Alignment completed, Roll Angle = millirad (Alignment Initials:)	N/A
--	-----

The rotating coil should have its windings oriented that a 'zero' angle quoted for a pole is indeed zero relative to the horizontal axis defined by the alignment crew. (Angle of first south pole, and of higher multipoles is important).

6. Measure Inductance and Resistance of Quadrupole at Room Temperature

Use an HP inductance meter to measure the inductance of the quad at room temperature. Use the Keithley Micro-ohmmeter to measure the magnet's resistance at room temperature. Write values and ambient temp below.

Inductance of coil (mH):	9.45 mH
Resistance of coil (Ohms):	0.373 Ohm
Ambient temperature in degrees C	17.8 C

3

7. Power Leads Connection and Magnetic Polarity

Before connecting the magnet terminals to the MCOR power supply check that the internal wiring is correct by looking at the wiring diagram below and comparing it to the magnet's wiring. Even though this is a solid wire magnet there are 4 thermal switches, one attached to each coil and their wiring should also be checked against the wiring diagram. But do not connect the thermal switches to your power supply.

All these quads will be run in a bipolar mode and so the focussing ones will use the positive current and the defocussing ones will use the negative current. So the power leads should be hooked up so a positive current gives the magnetic polarities shown in the figure 2 below.

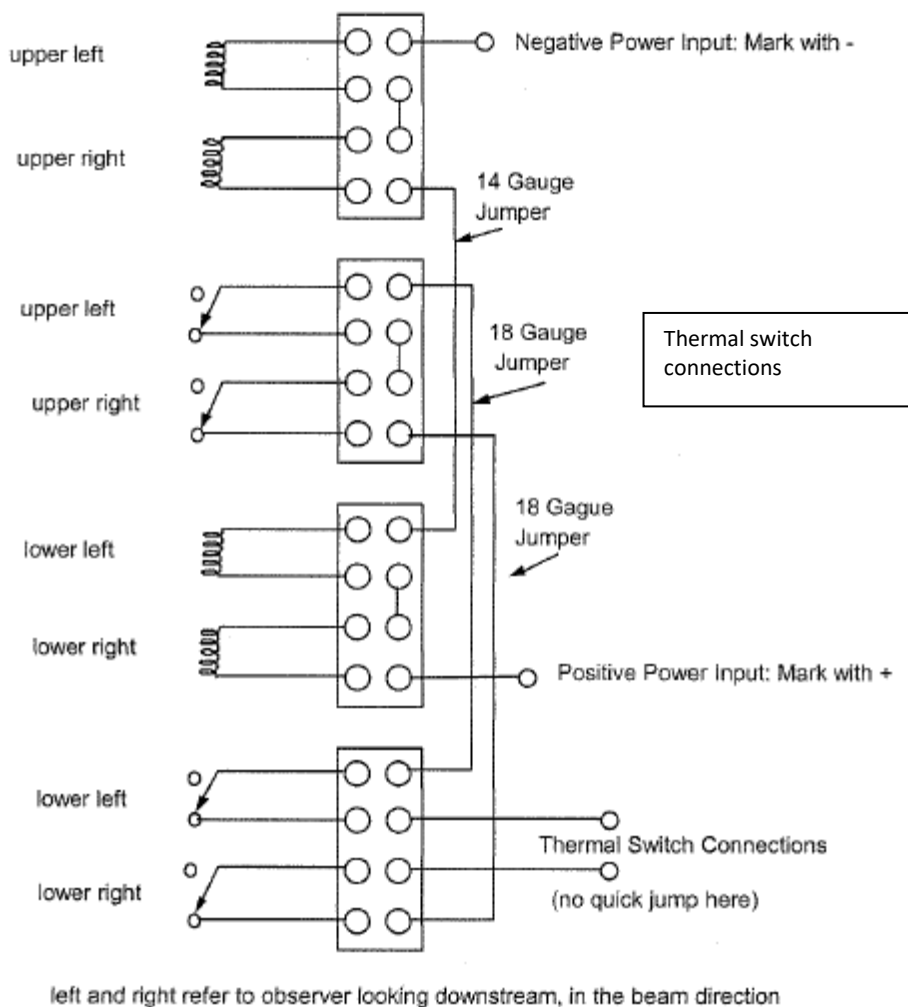

Figure 1. 1.26Q3.5 injector quadrupole internal wiring connections.

3

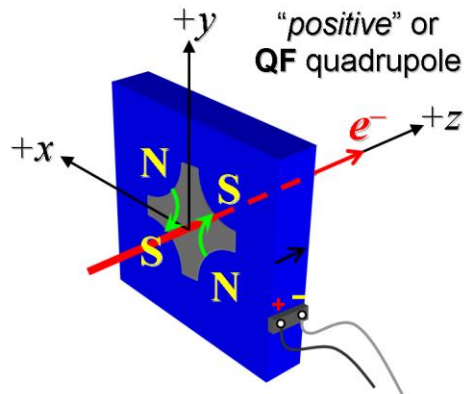

Figure 2. Determine the electrical polarity of the power leads that generate this magnetic polarity
Mark the electrical polarities of the power terminals with clear "+" and "-" labels.

Polarity has been labeled (initials):	SDA
---------------------------------------	-----

8. Thermal test on the very first 1.26Q3.5 quadrupole you measure.

The maximum integrated strength this type quad is required to produce is 10kG, according to the official physics requirement document and it is predicted this will be achieved at around 6 amps. Nevertheless the thermal test should be performed at 12 amps to check that the quadrupole will not get too hot if the accelerator operators decide a higher strength is needed or its power supply gets stuck at 12 amps during a standardization procedure.

So set the first quad up for a typical magnet thermal test: put thermocouples on the outer surface of one of the coils, on the steel of a poletip, on the top surface of its T1 support and in the ambient air (total of 4 thermocouples). Run the current up to 12 amps and measure and record the current, voltage of the magnet and 4 temperatures every 3 minutes. Observe the coil temperature every so often and reduce the current to 10 amps if it should approach 85 °C. Run the 12 amp current for at least 6 hours or until the coil temperature has stabilized and is no longer increasing.

Put the rtdat.rnn data file on the MMG's webpage for the first quad and let the Magnet Engineer know it is there so the data can be evaluated right away. This data will be used to determine if each quad needs to be run at some current for some period at the beginning of its set of measurements in order to be "warmed up".

Thermal test completed in hours on. Data in run:	N/A
--	-----

9. Initialization

Although these quadrupoles have been run before at their vendor's shop we will assume they were not run in the correct polarity nor standardized through many cycles and therefore are considered "virgin" magnets which need to be initialized. With the quadrupole in the correct polarity as described in section 7, take the magnet

3

from -12 amps to + 12 amps and back to -12 amps seven times at 1 amp per second ramp rate all the way (no need to slow down the ramp rate at any time). Pause for 60 seconds at every -12 amps and every + 12 amps.

Initialization completed on:	11/18/2016, by Scott Anderson
------------------------------	-------------------------------

10. Standardization and Setting Procedures

The new MCOR power supplies that will power the 1.25Q2.5 quads in the LCLS-II will be controlled by a new style PS controller which will have firmware embedded in it that allows up to three different ramp rates to be chosen and pause times to be chosen too. So program your MCOR to mimic these procedures described below.

Standardization Procedure

Using a 1 Amp per second ramp rate and starting from zero amps, go to +12 amps, then go through 3 full cycles from +12 A to -12 A and back up to +12 A, finally ending down at -12A from which the first operating current will be reached. Pause for 30 seconds at all +12A and -12A currents.

During standardization use just the 1A/s ramp rate. As usual the operating current will be approached "from below", so always finish the standardization at -12A.

Setting Operating Current Procedure

The new MCOR power supply controller has a "3-Linear Ramping Trim" capability which LCLS-II will use on all 1.26Q3.5 quadrupoles to minimize overshooting the operating current. Here is how it works, IDES is the current to be set next:

- (a) Go to 90% of IDES at 1 A/sec
- (b) Go the remaining 9% of IDES at 0.1 A/sec
- (c) Go the remaining 1% of IDES at 0.01 A/sec
- (d) Wait for a 10 seconds "settle" time before performing any measurements.

11. Magnetic Measurements

If the half-circle Al pieces attached to adjacent poletips are in your way you may remove them in order to do the measurements. Before you place the rotating coil in the aperture please do the Hall Probe measurement so the effective length can be calculated.

Warm-up the quadrupole before any magnetic measurements.

If the quadrupole has not been turned on for over an hour then it will need to be warmed up in the following way just before the standardization procedure that usually proceeds a magnetic measurement:

Turn on the MCOR power supply and increase the current to +6 amps using the "3-linear ramping trim". Leave the quadrupole running at +6 amps for 30 minutes, then reduce the current back to zero and carry out the measurement step as described in this plan without any delay.

3

(a) Hall Probe measurement of the poletip field at -12A

After a standardization procedure (see section 10 for details) , with the current at 12A, measure the field at the tip of each of the 4 poles, as best you can, with a Hall Probe. Correct the field values for the thickness of the Hall Probe; calculate and record the mean field value and its standard deviation. Note the experimental measurement error on a typical poletip field that arises from not being sure where the tip is precisely.

Standarization completed on:	11/18/2016, SDA
Actual current when measurements taken (nominal -12A)	-12.00601 A
Corrected poletip field mean value	0.295 T
Experimental error in measuring a poletip field on this quad	+/- 0.005 T

(b) Rotating Coil measurements of integrated gradient at set of currents

(i) Insert a rotating coil in the quad’s aperture and align it to be on the mechanical center of the quad as defined by the fiducialization data. Align the rotation of the measuring coil so its data will show the first south pole at 45 degrees.

Rotating Coil Designation (Name)	1_124DQB22_4_Layer
Rotating Coil Radius	0.0140208 m

(ii) Warm-up the quadrupole before any magnetic measurements.

If the quadrupole has not been turned on for over an hour then it will need to be warmed up in the following way just before the standardization procedure that usually proceeds a magnetic measurement:

Turn on the MCOR power supply and increase the current to +6 amps using the “3-linear ramping trim”. Leave the quadrupole running at +6 amps for 30 minutes, then reduce the current back to zero and carry out the measurement step as described in this plan without any delay.

(iii) If the quadrupole has been powered down since the standardization that was done just before the Hall Probe measurements described in section 11 (a) then it will need to be standardized again, as described in section 10. Otherwise continue on from the -12 A setting that was reached at the end of the most recent standardization.

Measure the integrated gradient, $\int Gdl$, from -12 to +12 A in 1A steps (25 ‘up’ measurements), and then back down from +12 A to -12 in 1A steps (25 ‘down’ measurements). Use the “3- Linear Ramping Trim” procedure to change the current from one value to the next. Pause 10 seconds after each new current is reached before taking any measurement data.

Filename & run number of best $\int Gdl$ up & down data:	Strdat.ru1
<i>Date of this measurement, Operator’s initials</i>	11/18/2016 SDA

3

(c) Rotating Coil measurements of harmonics at set of currents

During the $\int Gdl$ measurement run also measure the multipoles through $n=16$ at these 6 currents: -12, -6, -1, +1, +6 and +12 amps. Measure the strength and angle of each multipole component. Multipole values should be given as a percentage of the quadrupole moment calculated at a 1.0 cm radius. Also provide the magnetic center X and Y coordinates measured during the harmonics measurements at the above currents.

Filename & run number of best harmonics data:	Hardat.ru1
Date of this measurement and Operator's initials	11/18/2016, SDA

12. Saving and distributing data; receiving permission to remove the quad from the measurement table

(i) Put all the measurement data files for this quad in a subdirectory on the MMG website as described in section 4.

(ii) Inform the cognizant Magnet Engineer by email when there is data to be reviewed in that subdirectory, by sending the electronic copy of this traveler (which must have a unique name) with all its sections up to this point filled in to said engineer.

Do not disconnect or remove the magnet from your measurement stand until you receive word from the cognizant Magnet Engineer that they have reviewed and analyzed the data and are satisfied with it.

Permission to remove magnet received from	Mark Woodley
On date, MMG Operator's initials:	SDA

(iii) Finish filling in this measurement plan and traveler after permission to remove the magnet has been received and send it as an attachment to an email to the cognizant Magnet Engineer, also place it in the MMG subdirectory on the Web for the measurement data taken on this magnet as listed in section 4. The format of the name of this electronic WORD file should be MstTravName of magnet type_Beamline name of quad.

Magnet removed from MMG stand and left outside MMG's cage door for MFD to take	SDA
On date: MMG Operator's initials:	11/21/2016

Name of Final WORD file version sent to	LCLS-II 4010 1.26Q3.5.docx
Name of Magnet Engineer and Date	John Amann
by MMG Operator's initials:	SDA